



**Solid**World  
GROUP

**Investor Access  
Event**

**10<sup>th</sup> October 2023, Paris**

# Agenda

---

- 1 • Company at a glance
- 2 • H1 2023 Financial Highlights
- 3 • Strategic drivers and achievements
- 4 • Annex

# Today's Speakers



**Roberto Rizzo**  
Founder and CEO

- Founder and Chairman of Solid World S.r.l. (Treviso) from 2003
- Founder of Cad-Cam Studio (Treviso), 1986 – 2003
- Between 1984 and 1985 he developed a CAD software for the European Space Agency (ESA) at the Italspazio Consortium



**Elisabetta Cammarata**  
CFO and IR Manager

- CFO of SolidWorld Spa (Bentivoglio) from 2008
- From 1997 to 2007 Administrative Officer of Microsystem S.r.l.
- Back-office employee at Microsystem S.r.l., 1994 – 1997

# **1 • Company at a glance**

---

**SoldWorld Group is the leading Italian 3D digital system integrator for manufacturing companies, supporting and accelerating their journey to Industry 5.0.**



# SolidWorld Group's 3 Pillars

## CAD-CAM & ADDITIVE MANUFACTURING VAR



### PROPRIETARY IP

#### Software

Connecting CAD-CAM with  
enterprise and manufacturing  
systems



#### Turnkey Platform

Our own platform for delivering  
turnkey manufacturing projects



**Industry 4.0/5.0**

## MEDICAL APPLICATIONS

Additive medical models

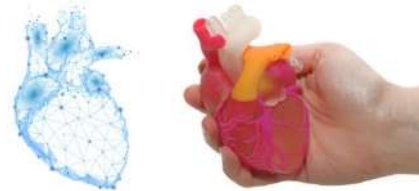

**3-D Bioprinting**



**Biomedical**

## SOLAR PANEL

Photovoltaic panel construction  
systems



**Solar**

# 20 years of value creation through bolt-on acquisition and synergies

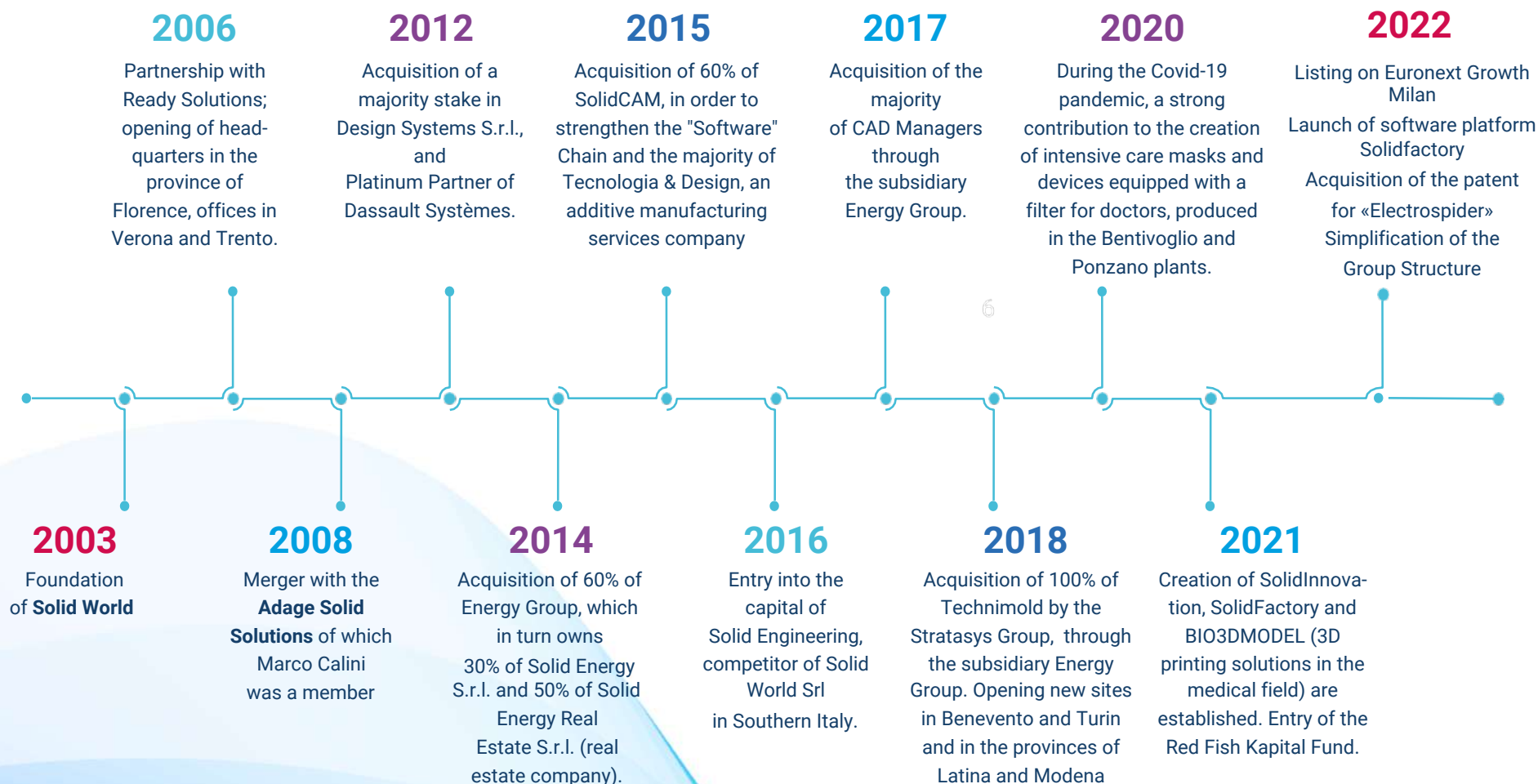

## 2023

**January**

- Open an office in **Dubai**

**February**

- Started the production of «**Electrospider**»

**July**

- **Acquisition** of a business unit from the company Formula E to enter the **global solar market**

**August**

- Acquisition of Valore BF 3D to **strengthen** the position in the Italian **3D design and software segment**.

# Distinctive competitive factors



## Technological Leadership

Leading developer and integrator of 3D software and hardware.  
Proprietary software Integr@



## Consolidated and valuable partnerships

Authorized reseller of Dassault Systèmes's 3D CAM solutions and training centre authorized by Stratasys



## Strong Customer Base

Leading players and well-established brands in different sectors (aerospace, automotive, home design, fashion)



## Unique 3D Offer

Customer support through both the best digital technologies and 3D printing solutions



## Experienced Management

Highly qualified management team with strong experience in the sector involved in the shareholders' base



## Innovation

Developer of innovative materials and quick solutions for the industrial and biomedical sector ensuring processes' efficiencies



Developing of innovative materials

International presence

Cost savings

Reduction Time-to-Market

Increased Productivity



# Industry 4.0/5.0 – CAD/CAM & Additive VAR

SolidWorld Group is the leading Italian 3D digital system integrator for manufacturers, supporting and accelerating their journey to Industry 5.0.



3D Scanning



3D Advanced Design System



3D Printing



3D Manufacturing



3D Printing Services



3D Academy

**> 20**

Years of Experiences  
in 3D Digital World

**14**

Locations  
throughout Italy



**172**

Group's Employees  
as 30 June 2023

**10,000**  
Clients



# Biomedical – Major 3D Bioprinting Innovation

Tissues printed by current 3D bioprinting offerings are limited in their applications by lack of structure

SolidWorld's highly innovative Electros spider machine solves that problem



## Electros spider

- Combines electrospinning and extrusion techniques to deliver superior organoids and tissue samples
- Collaboration with Pisa University, leading Italian science athenaeum
- Worldwide patents secured in 2022
- Already in production at Barberino plant

Multiple indications of interest from hospitals and medical research institutions. One €650,000 order already secured for September delivery.

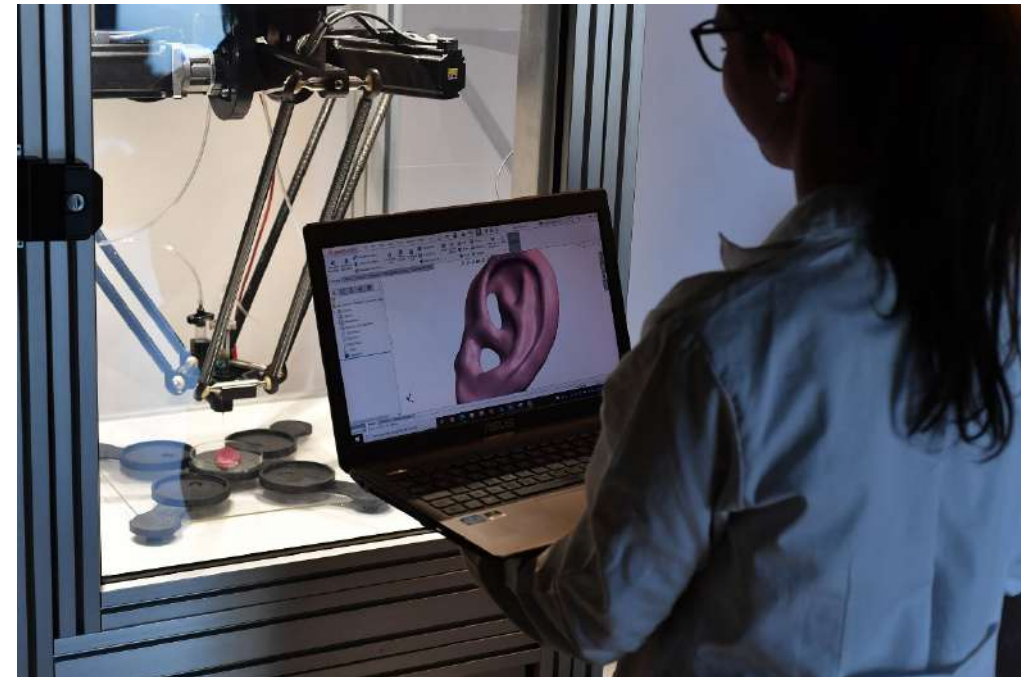

# Biomedical – 3D Bioprinting Market Sizing

Market researchers forecast growth to \$ 5.8bn  
By 2030(\*Average of 7 market reports)

The size and scope of the markets where 3D  
Bioprinting likely to take share or play an active  
part lends credence to forecasts

\$1.8  
bn\*  
2022



\$5.8bn\*  
2030

## Clinical Trials

~\$50bn\*  
2022

Electrospider delivers a significant improvement in the quality of organoids for drug testing - likely to drive adoption in this vast market

*\*Average of 7 mkt research firms*

## Animal Testing

Ethical concerns a driver for adoption

## Cosmetics Testing

Bioprinting various skin types for testing

## Organ Transplants



**THE FUTURE** – Our unique technology represents a major step toward the production of viable human organs for transplants

## Precision Oncology

Tumour printing for therapy formulation

## Vaccine Development

Bioprinting will accelerate pandemic reaction time

# Industry 4.0/5.0 – SolidWorld Proprietary IP

## Integr@

## SolidFactory

Your passport to operational excellence

### Integra Suite

Developed entirely by SolidWorld Group

Enables seamless integration of:

- CAD (design software)
- PDM (product data mgmt)
- ERP (enterprise system)

By optimizing project data handling, Integr@ reduces time wasting and improves outcomes

### SolidFactory Platform

Launched in 2022

Leveraging group capabilities and offerings to deliver turnkey projects

3 broad service groupings:

- Mechanical
- Automation
- Digital





## **2. H1 2023 Financial Highlights**

# Consolidated Financial Highlights H1 2023

**EUR 33.1 million**

**Revenues**

YoY +9.3%

**EUR 35.2 million**

**Value of Production**

YoY +11.1%

**EUR 2.7 million**

**EBITDA Adjusted**

**7.7%**

**EBITDA Adjusted %**

**EUR 12.8 million**

**Net Financial Position (Debt)**

**EUR 0.4 million**

**Net Profit**

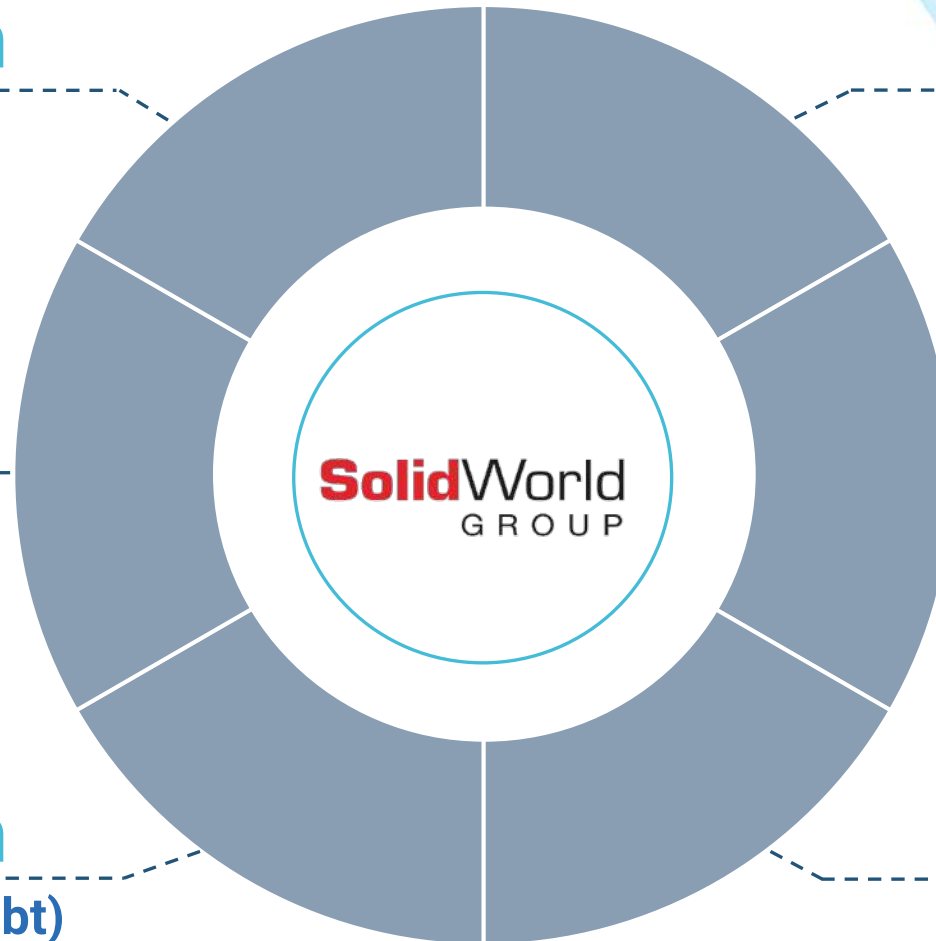

# H1 2023 Revenue Breakdown

## Breakdown by Revenues Type

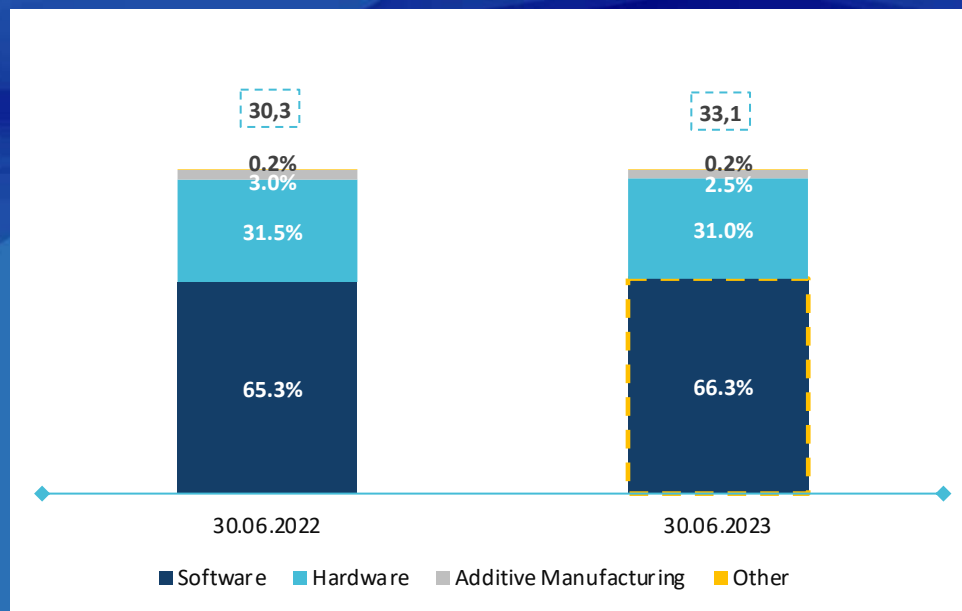

## Breakdown by Revenues of Business Software Line

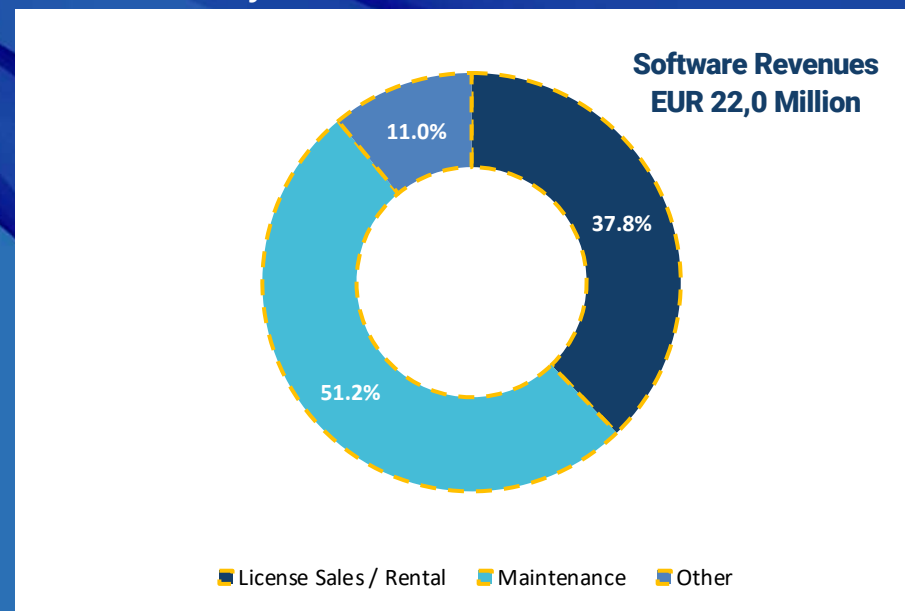

- As of 30 June 2023, the Group reported consolidate sales revenue of **EUR 33.1 million**, of which approximately 66,3% was attributable to the Software Sales business line, an activity pursued by the companies SolidWorld Group, Solidcam, SolidEngineering, Design System, Solid Innovation, Solid Factory and Solid World Middle East. This figure increased slightly compared to 30 June 2022, in which the Software Sales business line accounted for approximately 65,3%.
- The Hardware Business Line**, which includes Energy Group - which the companies Cad Manager and Technimold were merged into - and BIO3DMODEL, accounted for **approx. 31%** as at 30.06.2023.
- During the period under consideration, the **Additive Manufacturing Services Business Line**, represented by the company Tecnologia & Design, accounted for **approx. 2,5%**.
- The "Other" Business Line includes the companies Solid Energy Real Estate and Costa Alta, which are mainly related to the Group's real estate business and are represented entirely by intercompany revenues.

- As at 30.06.2023, the Group recorded revenue from the Software business line of approx. EUR 22,5 million.
- Revenues from Software Sales can be broken down as follows
  - Sales/rental of software licences**, amounting to approx. **EUR 8,5 million** at 30.06.2023 (37,8% of revenues from the Software Business Line)
  - Revenues from **Maintenance**, including Initial Subscription and Renewal Subscription, amounting to approx. **EUR 11,5 million in** at 30.06.2023 (approx. 51,2% of Revenues from Software Business Line)
  - Other Revenues, including revenues from workstations, training and other services, amounting to approx. **EUR 2,5 million** at 30.06.2023 (approx. 11% of Revenues from Software Line of Business)

# Consolidated Profit and Loss

Profit and Loss	30.06.2023	30.06.2022	30.06.2023	30.06.2022
Data in Euro	Actual	Actual	% on VoP	% on VoP
① Net Revenues	33.135.248	30.310.371	94,03%	95,58%
SF and F products inventories	22.566	33.233	0,06%	0,10%
② Increase in assets	1.374.477	871.443	3,90%	2,75%
Other revenues	705.241	495.733	2,00%	1,56%
<b>Value of Production</b>	<b>35.237.531</b>	<b>31.710.780</b>	<b>100,00%</b>	<b>100,00%</b>
Δ Purchases net of change in raw materials	-20.547.662	-18.716.670	-58,31%	-59,02%
Services	-4.409.059	-4.063.257	-12,51%	-12,81%
Use of assets owned by others	-902.852	-723.387	-2,56%	-2,28%
Employees Cost	-6.183.855	-5.134.845	-17,55%	-16,19%
Other operating costs	-431.401	-598.056	-1,22%	-1,89%
③ <b>EBITDA</b>	<b>2.762.703</b>	<b>2.474.565</b>	<b>7,84%</b>	<b>7,80%</b>
Extraordinary item (income)	-103.903	-164.914	-0,29%	-0,52%
Extraordinary item (costs)	51.203	233.169	0,15%	0,74%
④ <b>EBITDA Adjusted</b>	<b>2.710.003</b>	<b>2.542.821</b>	<b>7,69%</b>	<b>8,02%</b>
D&A	-1.304.231	-865.003	-3,70%	-2,73%
Provisions	-270.749	-429.869	-0,77%	-1,36%
<b>EBIT</b>	<b>1.187.722</b>	<b>1.179.693</b>	<b>3,37%</b>	<b>3,72%</b>
Financial results	-309.483	-267.520	-0,88%	-0,84%
<b>EBT</b>	<b>878.239</b>	<b>912.173</b>	<b>2,49%</b>	<b>2,88%</b>
Income Taxes	-449.996	-596.214	-1,28%	-1,88%
⑤ <b>Profit (Loss) for the fiscal year</b>	<b>428.243</b>	<b>315.959</b>	<b>1,22%</b>	<b>1,00%</b>
<b>Group's Profit (Loss) for the fiscal year</b>	<b>640.503</b>	<b>387.155</b>	<b>1,82%</b>	<b>1,22%</b>
<b>Third Parties' Profit (Loss) for the fiscal year</b>	<b>-212.260</b>	<b>-71.196</b>	<b>-0,60%</b>	<b>-0,22%</b>

## Comments

- ① **Net Revenues** increased at 30.06.2023 (YoY +9.3%) to EUR 33.1 million. This growth is mainly attributable to Solid World and Energy Group, which recorded YoY revenue increases of approx. EUR 2.6 million and EUR 3.6 million, respectively. Revenue's increase is only partially influenced by merger operations.
- ② **Increase in assets** equal to approx. **EUR 1.4 million** and mainly referable to the capitalization of personnel costs (90% of total amount). This item is mainly associated with Solid World, Bio3DModel, T&D and Solid Factory, whose business model require substantial investments in R&D.
- ③ **EBITDA** is growing compared to the previous period, both in terms of absolute value and percentage. The % growth is only minimally impacted by the expected benefits resulting from the integration process carried out by the Group as a result of the recent merger operations, which are currently in the development phase.
- ④ **EBITDA Adjusted** amounts to EUR 2.7 million, showing an increase compared to the previous period as a direct consequence of EBITDA growth. The slight percentage decrease is mainly attributable to the lower extraordinary costs incurred by the Group during the current semester.
- ⑤ **Profit for the fiscal year** increased compared to the previous fiscal year (YoY +35.5%) and amounts to approx. EUR 0.4 million.



# EBITDA Adjusted Bridge

Euro'000

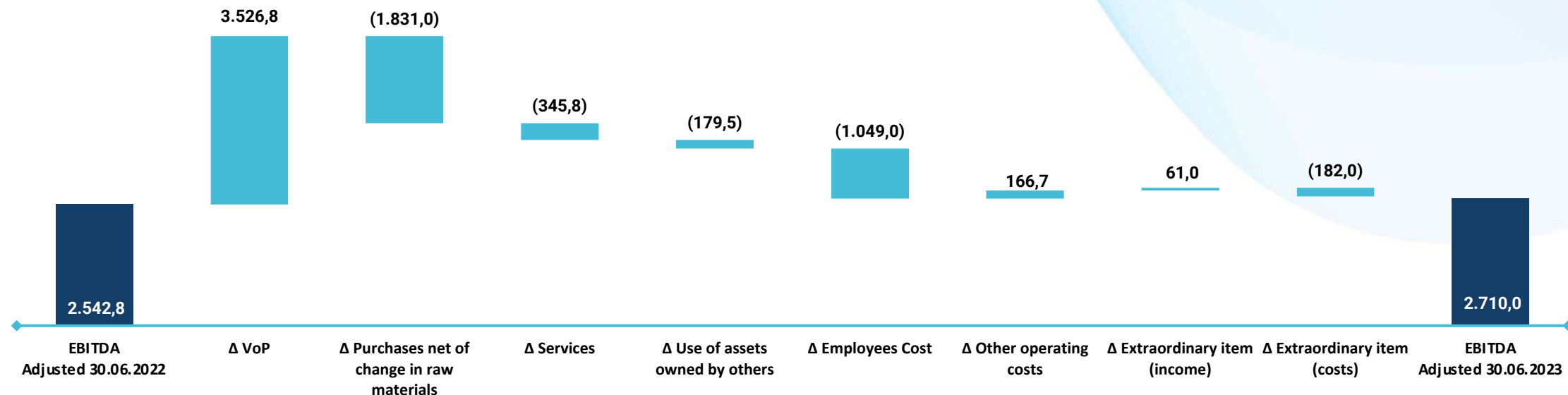

- ① **Adjusted EBITDA** 30.06.2023 grew in the period and amounted to **EUR 2.7m**, despite showing only minimal effects stemming from the integration process carried out by the Group.
- ② **Δ Value of Production of approx. EUR 3.5 million**, driven by the increase in revenues mainly attributable to the Software business line, amounting to approx. EUR 22,5 million compared to approx. EUR 20,4 million at 30.06.2022.
- ③ **Δ Purchases net of change in raw materials**: These item mainly include purchase costs related to Software, Hardware and Consumables as a direct consequence of the increase in sales revenues considering the core business of the Group.
- ④ **Δ Service Costs**: Equal to **approx. EUR 0.3 million** and mainly driven by partial set up of the cost structure related to Solid Factory and Middle East.
- ⑤ **Δ Personnel**: Equal to **EUR 1.0 million** due to i) the hiring of 24 new resources during the year, totalling 194 compared to 170 in the previous year and ii) the increase in R&D costs incurred.

# Net Profit Bridge

Euro'000

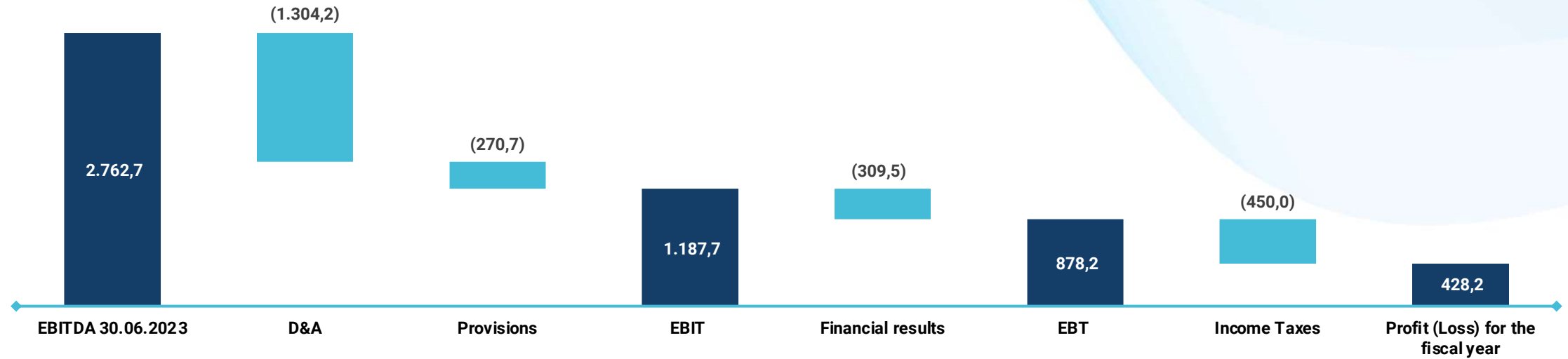

- ① **Depreciation, Amortisation and Write-downs** amounting to EUR 1.3 million at 30.06.2023, of which approx. EUR 1.0 million relating to Intangible Assets and approx. EUR 0.2 million relating to Tangible Assets.
- ② **Provisions** of approx. EUR 0.3 million, mainly due to provisions for Help Desk service charges.
- ③ **Financial Result** amounting to ca. EUR 0.3 million and mainly driven by interest under the Amortisation Plans previously stipulated by the Group and the transaction with Riello Investimenti Partners SGR.
- ④ **Income Taxes** down in percentage terms from the previous year due to the benefits produced by the application of the 110% super deduction regulations (the so-called new 'Patent box').

# Consolidated Balance Sheet

Balance Sheet	30.06.2023	31.12.2022
Data in Euro	Actual	Actual
① Intangible Fixed Assets	12.851.475	11.414.086
Tangible Fixed Assets	9.538.472	9.352.531
② Financial Fixed Assets	788.525	1.175.076
<b>Total Fixed Assets</b>	<b>23.178.471</b>	<b>21.941.694</b>
Inventories	3.383.277	2.619.249
Account receivables	16.209.178	18.718.061
(Payables to suppliers)	-11.360.515	-12.519.021
<b>Commercial Working Capital (CWC)</b>	<b>8.231.940</b>	<b>8.818.289</b>
③ Other current assets	1.215.852	3.526.083
④ Other current liabilities	-4.779.484	-8.133.889
Tax Receivables and Payables	-1.014.693	-1.114.562
Accruals and Prepayments	-748.280	-161.298
<b>Net Working Capital</b>	<b>2.905.335</b>	<b>2.934.623</b>
Severance indemnities (TFR) fund	-1.399.413	-1.354.449
Other funds	-2.695.623	-2.620.936
<b>Net Invested Capital (NIC)</b>	<b>21.988.770</b>	<b>20.900.932</b>
Current part of non-current financial debt	3.180.285	2.759.079
Current financial debt	5.055.856	5.461.163
Non-current financial debt	7.448.561	7.910.503
<b>Total bank and financial debt</b>	<b>15.684.703</b>	<b>16.130.745</b>
Other current financial assets	-186.072	-589.504
Cash and Cash equivalents	-2.712.239	-3.290.041
⑤ <b>Net Debt</b>	<b>12.786.391</b>	<b>12.251.201</b>
Capital	1.165.700	1.165.700
Reserves	7.104.548	7.174.795
Profit (Loss) for the fiscal year	640.503	104.396
<b>Shareholders' Equity</b>	<b>8.910.751</b>	<b>8.444.891</b>
<b>Third Parties Shareholders' Equity</b>	<b>503.887</b>	<b>194.622</b>
<b>Third Parties' Profit (Loss) for the fiscal year</b>	<b>-212.260</b>	<b>10.218</b>
<b>NFP and Shareholders' Equity</b>	<b>21.988.770</b>	<b>20.900.932</b>

Comments
① <b>Intangible fixed assets</b> , amounting to <b>EUR 12.8 million</b> at 30.06.2023, increased compared to 2022, mainly due to i) the capitalisation of personnel costs and ii) the goodwill generated by the corporate restructuring in SolidFactory.
② <b>Financial Fixed Assets</b> , equal to <b>EUR 0.8 million</b> at 30.06.2023. The decline is mainly attributable to the stake previously held by Solid World in ABM Works, which is no longer present due to the corporate restructuring carried out in Solid Factory, resulting in the recognition of the corresponding goodwill among Intangible Fixed Asset.
③ <b>Other Current Assets</b> amounting to <b>EUR 1.2 million at 30.06.2023</b> , decreasing compared to 2022 due to the reduction of anticipated costs for Software Support Contracts.
④ <b>Other Current Liabilities</b> amounting to <b>EUR 4.8 million at 30.06.2023</b> , decreasing compared to 2022 due to the reduction of prepaid revenues for Software Support Contracts.
⑤ <b>Net Debt</b> of ca. <b>EUR 12.8 million</b> at 30.06.2023, slightly increased compared to the previous fiscal year, primarily due to the reduction of other current financial assets.

# Net Debt Analysis

Euro'000

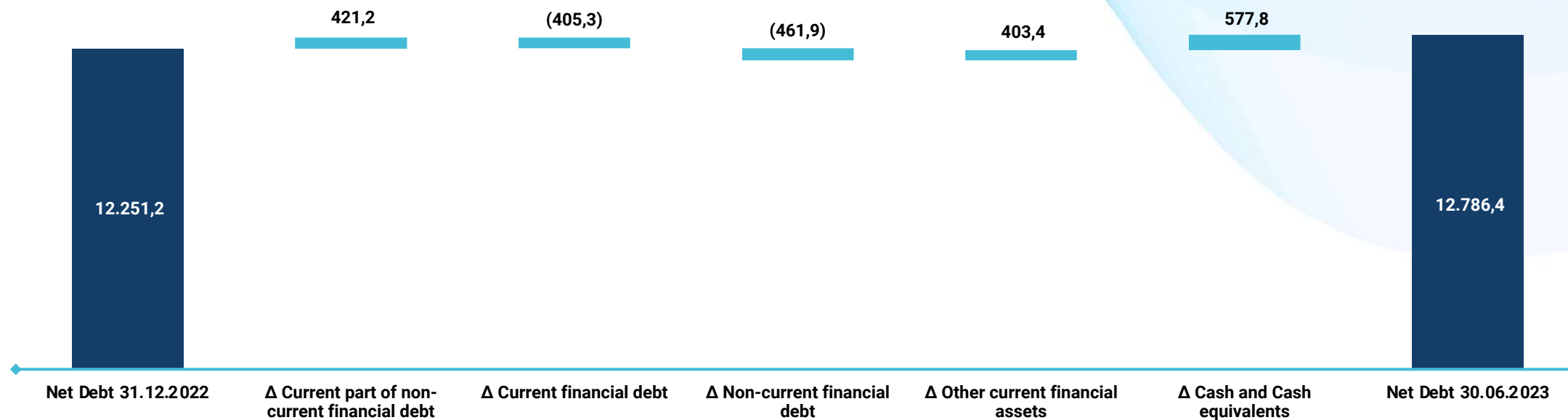

- ① Δ **Current part of non-current financial debt** increasing compared to 2022 due to new debt generated by the corporate restructuring in SolidFactory.
- ② Δ **Current financial debt** equal to approx. EUR -0,4 million and mainly composed by current bank debts.
- ③ Δ **Non-Current financial debt** equal to approx. EUR -0,5 million and mainly attributable to the new financing previously mentioned.
- ④ Δ **Other current financial assets** equal to EUR 0,4 million and mainly attributable to the reduction of other current financial assets.

# Consolidated Cash Flow

Cash Flow	30.06.2023	30.06.2022
<b>(Dati in unità di Euro)</b>		
<b>EBITDA</b>	<b>2.710.003</b>	<b>2.542.821</b>
Δ Inventories	-764.027	-465.314
Δ Account receivables	2.508.883	4.616.467
Δ (Payables to suppliers)	-1.158.507	-2.875.623
<b>Δ Commercial Working Capital</b>	<b>586.349</b>	<b>1.275.530</b>
Δ Other current assets	2.310.232	1.570.078
Δ Other current liabilities	-3.354.404	-2.549.605
Δ Tax Receivables and Payables	-99.869	-144.990
Δ Accruals and Prepayments	586.981	180.089
<b>Δ Net Working Capital</b>	<b>29.289</b>	<b>331.102</b>
Δ Several Funds	315.714	-226.756
Δ TFR Fund	74.687	-117.010
<b>Operating Cash Flow</b>	<b>3.129.692</b>	<b>2.530.157</b>
Capex	-2.927.561	-9.727.869
Δ Financial Fixed Assets	386.551	7.335.047
Income Taxes	-449.996	-596.214
<b>Free Cash Flow</b>	<b>138.686</b>	<b>-458.879</b>
Financial results	-309.483	-267.520
Δ Current part of non-current financial debt	421.206	129.290
Δ Current financial debt	-405.307	-5.002.595
Δ Non-current financial debt	-461.942	3.906.081
Δ Equity	39.037	1.934.341
<b>Net Cash Flow</b>	<b>-577.802</b>	<b>240.718</b>
<b>Net Cash</b>	<b>2.712.239</b>	<b>3.229.343</b>

# Outlook

All the sectors covered by the group show high growth potential and excellent profitability as well as the possibility of expansion into foreign markets.

The integration process between the group companies, aimed at streamlining processes and simplifying the organization, is currently being implemented and involves both the parent company and its subsidiaries.

In view of the above, the company will continue to invest in order to be a point of reference in the development of software, hardware and support and training services in the sectors in which it operates.

**SolidWorld**  
GROUP

### **3. Strategic drivers and achievements**

# Strategic drivers in Industry 4.0/5.0



## CONSOLIDATION OF THE COMPETITIVE POSITION

- ❖ Technological transition from **On Premise to In Cloud**
- ❖ Enhancement of **sales of own products Integr@ Software**
- ❖ Started collaborations in the **aerospace industry**
- ❖ **Launch** the **distribution** of 3D printers for decorations on fabrics and textiles



## STRENGTHENING OF THE POSITION IN 3D DESIGN AND SOFTWARE MARKET

- ❖ Launch of SolidFactory Platform providing **tailor-made consulting to support companies** in defining and rolling out strategies to automate production processes
- ❖ Acquisition of **Valore BF 3D (100%)**, newly established company which sells the SolidWorks 3D CAD software, developed by Dassault Systèmes SE, of which SolidWorld is also an authorized reseller in Italy.





# Strategic achievements in the Biomedical Sector

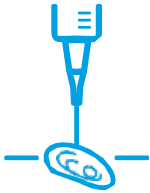

## INCREASE THE GROUP'S PRESENCE IN THE BIOMEDICAL SECTOR

- ❖ Acquisition of the **international patent** for Electros spider
- ❖ Started production of Electros spiders at Barberino plant, with an initial **capacity of 12 printers** worth €500,000 each
- ❖ Secured first **firm order** from a **major research institution**, worth >€600k



**Bioprinter market expected to grow at CAGR of 12.5%\* from 2023 to 2030.**

\*Source: Grand View Research

# Rationalization of the Group to exploit synergies



## PROCESS OF SIMPLIFICATION OF THE GROUP STRUCTURE

- ❖ **Leverage** operating, commercial, administrative and corporate synergies by **restructuring** and **optimising** the decision-making levels and personnel and overhead cost management
- ❖ Incorporation of the subsidiary **SolidEngineering**
- ❖ Incorporation of **Technimold** and **Cad Manager** Into **Energy Group**

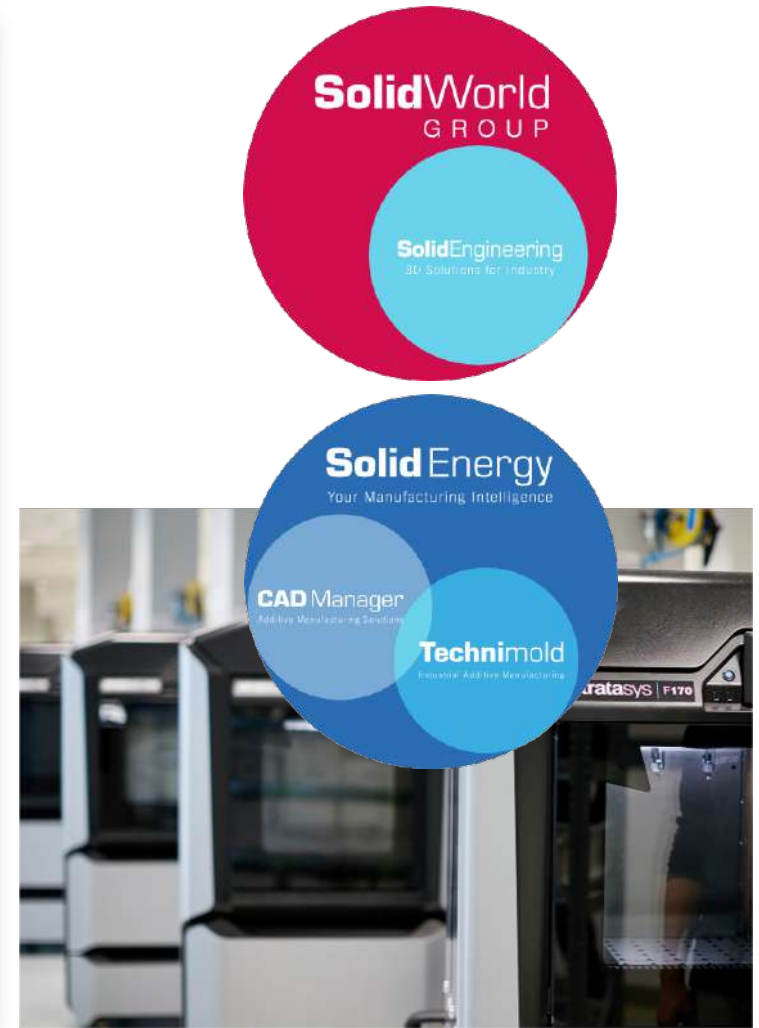

# Increase international presence of the businesses



## OPENING OF SOLIDWORLD MIDDLE EAST IN DUBAI

- ❖ Targets the **Middle East market** to support local businesses in the technological process of product development offering **integrated solutions** especially in the **biomedical sector**.



# Additional strategic pillar of development

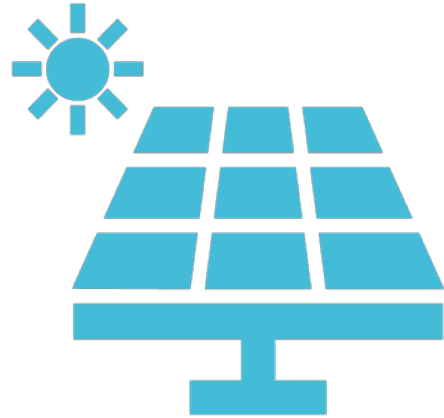

## ENTER IN THE RENEWABLE ENERGY SECTOR

- ❖ Completion, through the subsidiary **SolidFactory** of the acquisition of a technology business unit from **Formula E S.r.l (100%)**, active in automation for equipment dedicated to the **renewable energy sector**
- ❖ The Group will now be able to supply its customers with industrial machines for the **construction of photovoltaic panels**
- ❖ The goal of the transaction is **to establish a single competitive entity in the global solar market**, which is expected to register CAGR of 15.7% from 2022 to 2030\*.

\*Source: Grand View Research

## **4. Annex**

# SolidWorld Group Shareholding



**14,036,371**  
Shares outstanding

**7,049,918**  
Warrants outstanding

**17,561,330**  
Fully diluted shares

Shareholder	No. of ordinary shares	N. of shares	% on Share Capital	% on listed shares
<b>Roberto Rizzo</b>	2,077,670	4,282,840	30.51%	19.57%
<i>through PRIME S.r.l.*</i>	2,043,920	4,249,090	30.27%	19.25%
<i>as natural person***</i>	33,750	33,750	0.24%	0.32%
<b>Marco Calini</b>	1,128,420	2,343,090	16.69%	10.63%
<i>through AL. CA S.r.l.**</i>	972,750	2,022,750	14.41%	9.16%
<i>as natural person***</i>	155,670	320,340	2.28%	1.47%
<b>Lucio Ferranti ***</b>	417,500	417,500	2.97%	3.93%
<b>Other Shareholders subject to Lock-Up***</b>	1,078,820	1,078,820	7.69%	10.16%
<b>RedFish LongTerm Capital S.p.A.</b>	1,236,348	1,236,348	8.81%	11.65%
<b>RedFish Listing Partners Spa (già RedFish 4 Listing S.r.l.)</b>	385,875	385,875	2.75%	3.63%
<b>Market</b>	4,291,898	4,291,898	30.58%	40.43%
<b>TOTAL</b>	<b>10,616,531</b>	<b>14,036,371</b>	<b>100.00%</b>	<b>100.00%</b>

\*Company attributable to Roberto Rizzo, Chairman of the Board of Directors

\*\*Company attributable to Marco Calini, Deputy Chairman of the Board of Directors

\*\*\*Until 06 July 2024

**2 warrants = 1 share**

**Period of Exercise:**  
**July 2023 @ €2.20 ps**  
**(4,218,934 warrants converted)**

**September 2023 @ 2.42 ps**  
**(539,808 warrants converted)**

**July 2024 @ €2.42 ps**

**July 2025 @ €2.662 ps**

**From October 2023**  
**Allocation of free shares to all shareholders**



# Industry 4.0/5.0 - Clients and collaborations

Extensive customer base with more than 8.000 clients and consolidated relationships with the top Italian Universities.

Client diversification is extremely high (low concentration with top 10 clients reaching less than 10% of revenues).

## Client



## Collaboration with Top Universities



# 3D Design

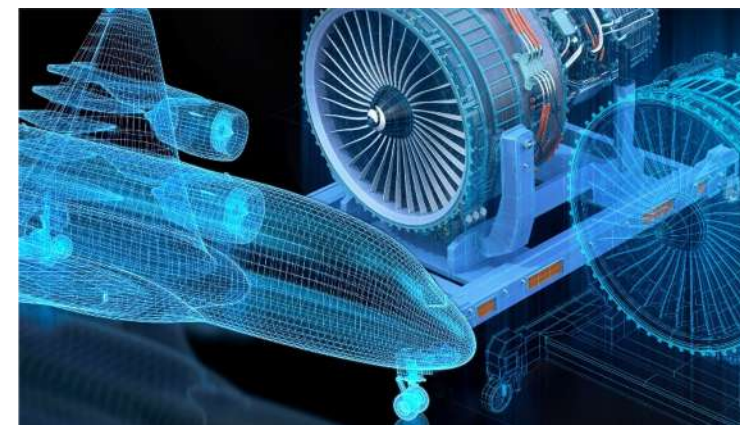
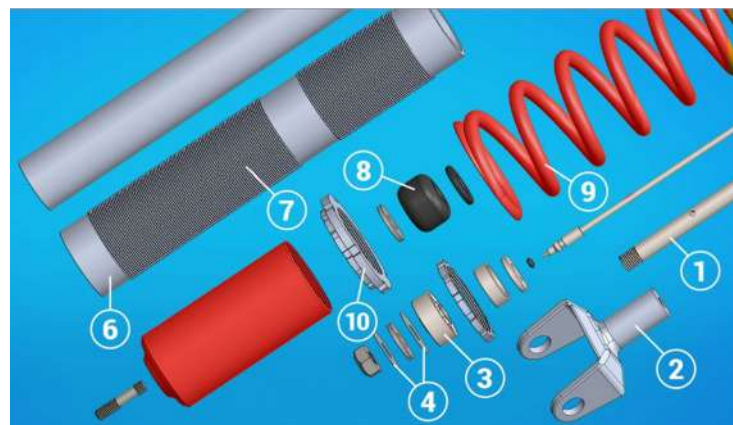
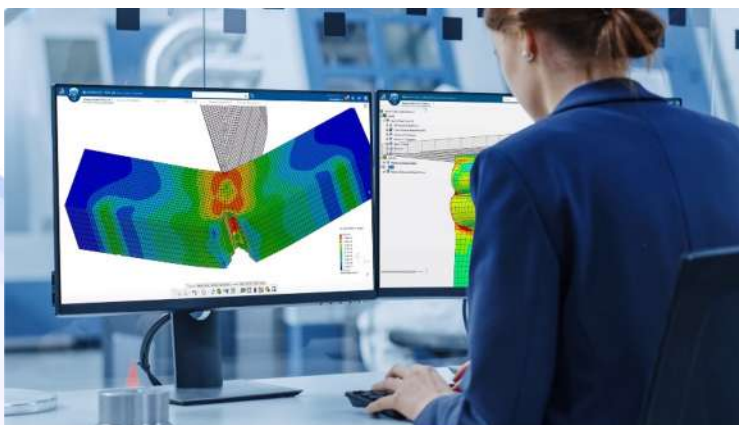
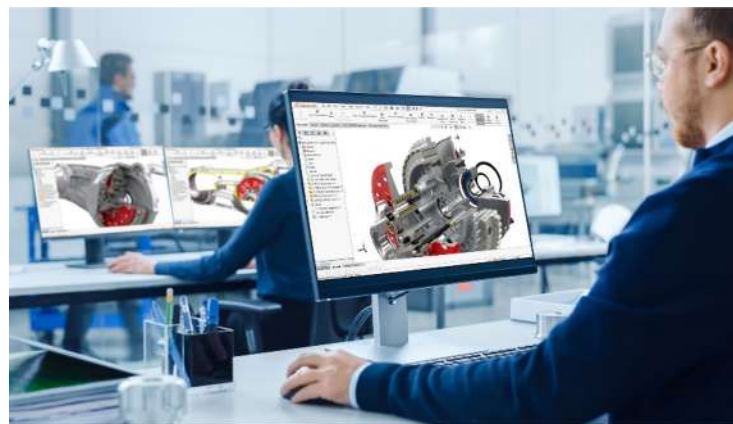



# 3D Scanner

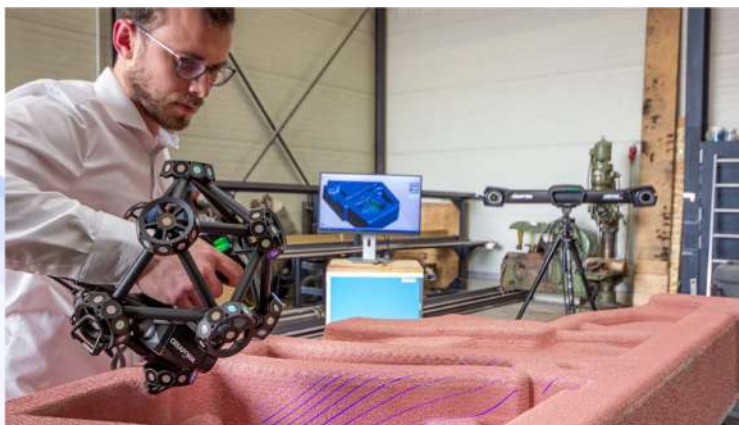

# 3D Printing

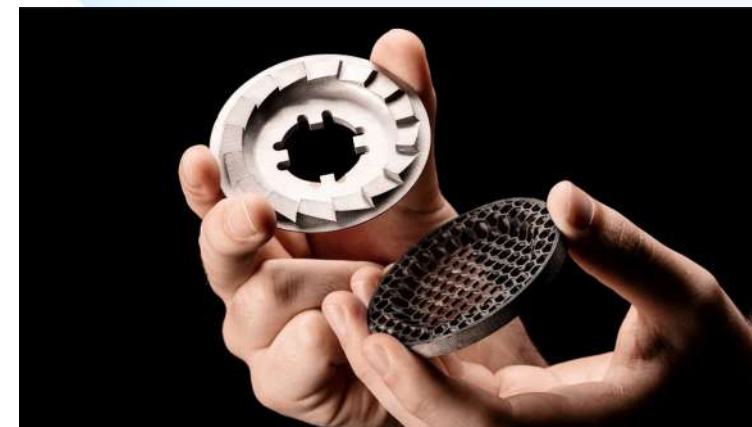

# 3D Manufacturing

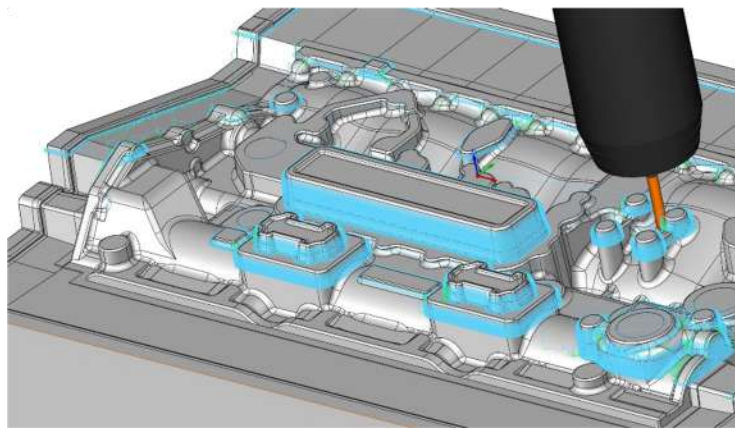
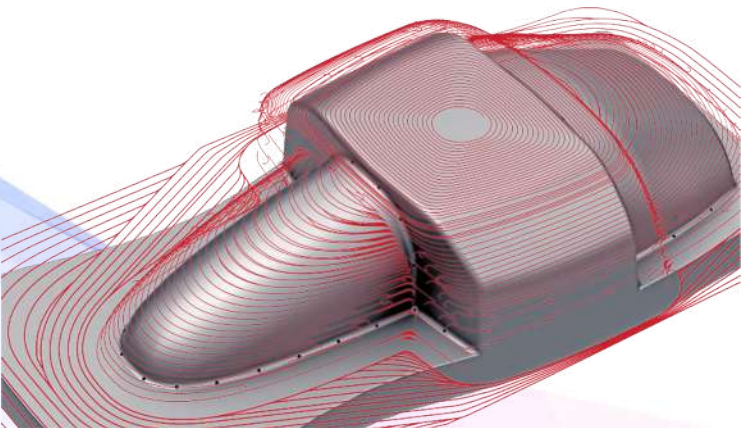
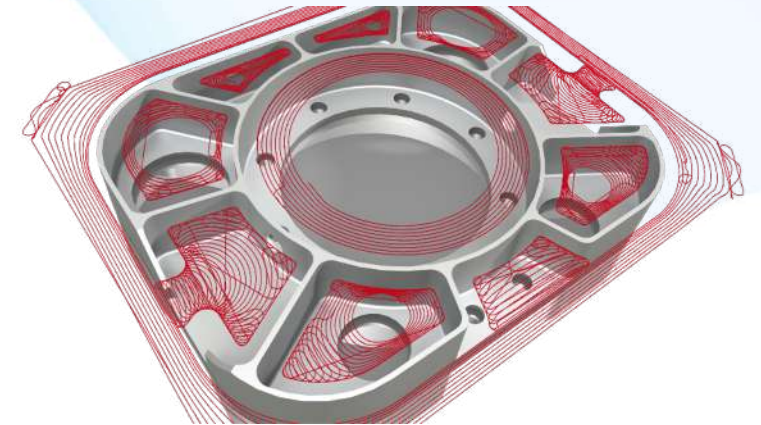

# Digital Factory

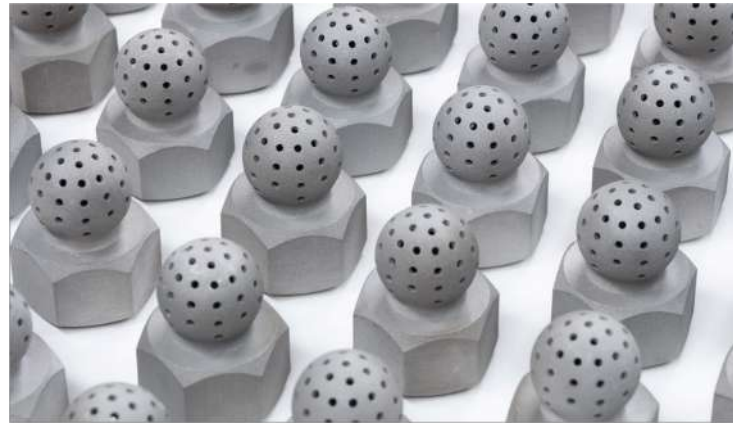

# Biomedical Applications

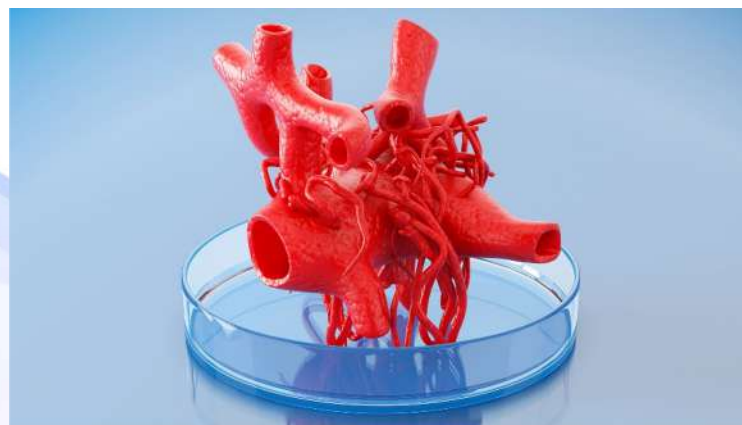
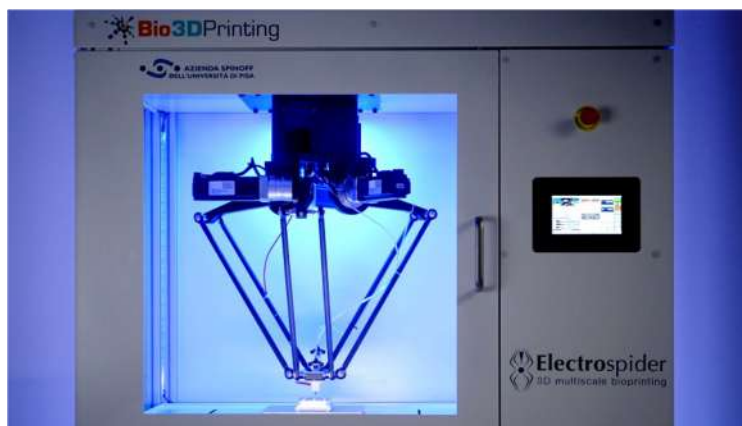

# Disclaimer

---

The information contained in this presentation, which has been prepared by SolidWorld GROUP S.p.A. (the “Company”) and its consolidated subsidiaries (together, the “Group”) and it is under the responsibility of the Company, does not constitute or form part of any offer to sell or issue or invitation to purchase or subscribe for, or any solicitation of any offer to purchase or subscribe for, any securities of the Company, nor shall it or any part of it nor the fact of its

distribution form the basis of, or be relied on in connection with, any contract or investment decision. The information and opinions contained in this document are provided as at the date of the presentation and are subject to change.

The Group expressly disclaims any duty, undertaking or obligation to update publicly or release any revisions to any of the information, opinions or forward-looking statements contained in this document to reflect any events or circum-

stances occurring after the date of the presentation of this document. No representation or warranty is made as to the achievement or reasonableness of, and no reliance should be placed on, such forward-looking statements. Any reference to past performance or trends or activities of the Company shall not be taken as a representation or indication that such performance, trend or activity will continue in the future.

This document may not be repro-

duced or distributed, in whole or in part, by any person other than the Company; by viewing and/or accepting a copy of this document, you agree to be bound by the foregoing limitations. Additional information on the factors that could have an impact on the Group financial results is contained in the documents filed by the Group and available on the Group’s website at [www.solidworld.it](http://www.solidworld.it).

# **SolidWorld** GROUP

The 3D Digital World

**Thank you!**